

Hansa concealed valve with Präzisa spindle headpart G 3/4 threaded connection

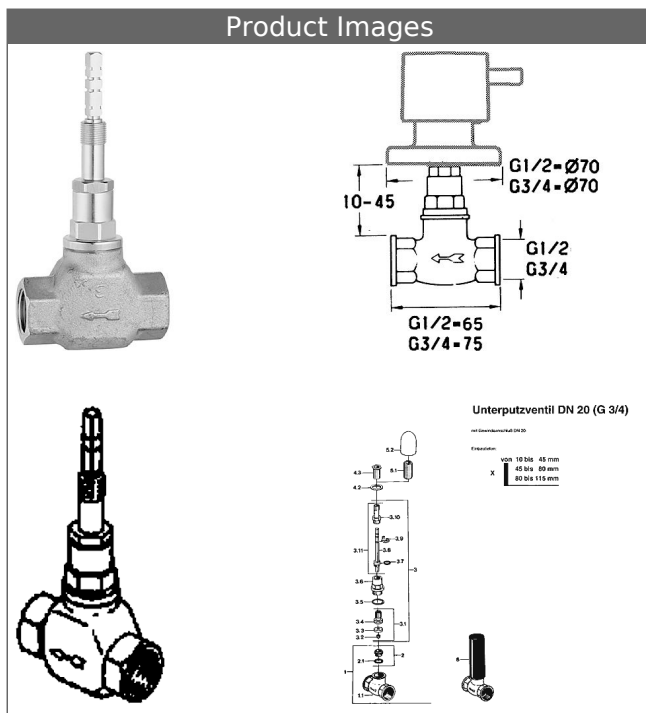

Description

Hansa concealed valve with Präzisa spindle headpart
G 3/4 threaded connection

flow rate: up to 48 l/min

- body: DR brass (MS 63)
- Präzisa spindle headpart
- exchangeable valve seat
- installation depth: 10-45 mm

Model	Item No.
	02210100 

Product Image



Product Drawing

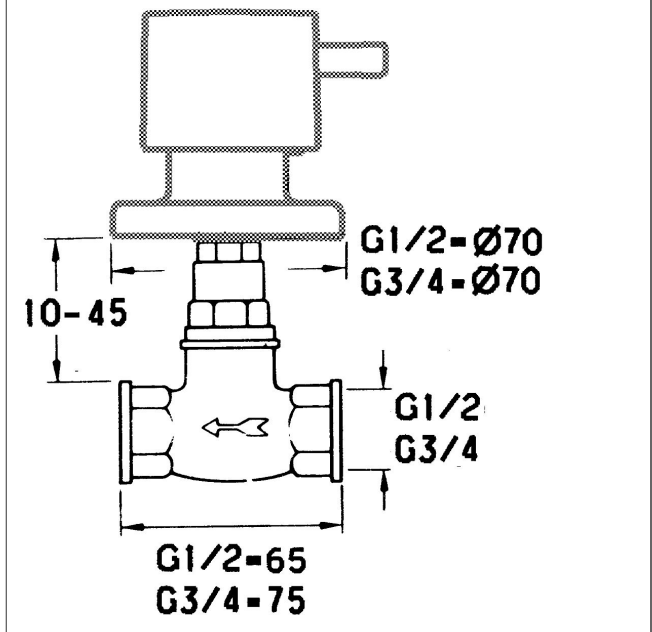

Product Drawing

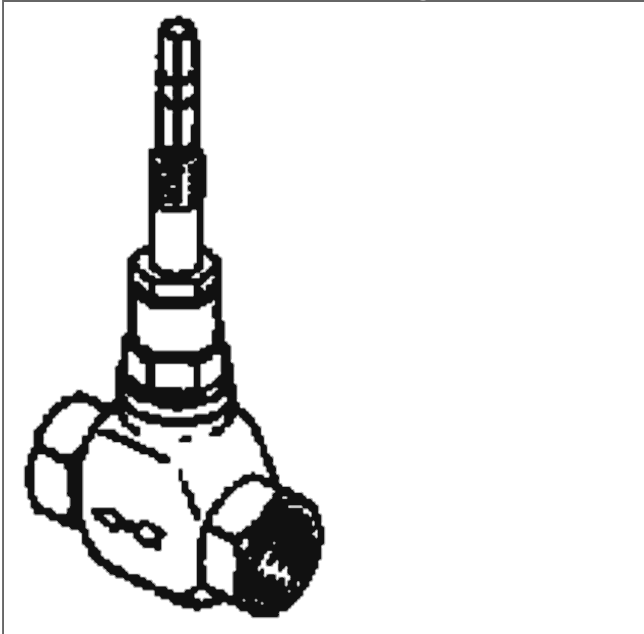

Product Drawing

